



**Solartron
Metrology**

SGIM

Strain Gauge Input Module



user manual

AMETEK[®]
ULTRA PRECISION TECHNOLOGIES

1.0 Index

Section	Title	Page
1.0	Index	2
2.0	Introduction	3
3.0	Description	3
4.0	Specification	3
5.0	Power Requirements.	4
6.0	Gain Settings	5
7.0	Full Bridge (Six Wire) Wiring	7
8.0	Full Bridge (Four Wire) Wiring	8
9.0	Precautions	8
10.0	Screen Connections	8
11.0	Thermal emfs	8
12.0	Earth Loops	9

Return Of Goods
Solartron Sales Offices

Introduction

2.0 Introduction

The SGIM is a low noise voltage source and amplifier to convert small strain gauge signals to the Solartron Orbit 3 digital network. Within the Orbit 3 network, the SGIM module appears as a +/-1 V AIM module.

See the Orbit 3 manuals for software and hardware interfacing details.

3.0 Description

The SGIM provides a regulated 5 V excitation voltage for full bridge (4 / 6 wires). Suitable for bridge elements down to 200 Ω . Strain gauges are typically 350 Ω .

The circuit design allows the selection of gain using miniature links with trimming pots providing fine control over the gain and offset settings. The full bridge configurations enable the application of Kelvin connections to eliminate the effects of wiring resistance.

4.0 Specification

See datasheet 503183



Note the ferrite cores are fitted to the SGIM & AIM unit as a precaution for noisy industrial applications.

Power requirements

5.0 Power Requirements











Solartron recommends powering SGIM from one of Power supply interface modules (PSIM), It is possible to power one SGIM from USBIM for testing / evaluation purposes. Current consumption is typically 0.14 A with a 350 Ω strain gauge and 0.17 A with a 200 Ω strain gauge.

	No of SGIM 350 Ω	No of SGIM 200 Ω
AC PSIM (1.8 A)	10	8
DC PSIM (1.8 A)	10	8
DC PISIM/24/5 (1.8 A)	10	8
AUX AC PSIM/24 (1 A)	6	4

Gain Settings

6.0: Gain Settings

Ten gain ranges can be selected using jumper link(s) J2 with fine gain provided by RV2 providing a continuous series of overlapping settings.

Setting	Links (J2)	Rated output mV/V
1		18-62
2		12-21
3		12-32
4		8-13
5		4.8-11
6		3-5
7		2-4.6
8		1.4-2.2
9		0.8-1.8
10		0.6-0.9

Gain Settings

- 3 Negative output from bridge (white)
- 4 Positive output from bridge (yellow)
- 6 Bridge high (+5) excitation (blue)
- Screen (SCRN)
- 5 Bridge high sense (green)
- 1 Bridge low (0V) excitation (black)
- 2 Bridge low sense (red)

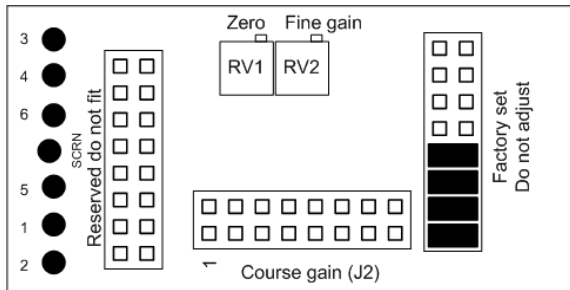

After selection of the appropriate gain links, J2, the system can be fine adjusted and calibrated for fine gain and zero using the multi-turn trimming potentiometers.

Full Bridge (Six Wire) Wiring

7.0 Full Bridge (Six Wire) Wiring

The cable screen should be continued to provide screening around the sensor. No electrical connection should be made from the screen to the actual sensor.

- 3 Negative output from bridge (white)
 - 4 Positive output from bridge (yellow)
 - 6 Bridge high (+5V) excitation (blue)
- Screen (SCRN)
- 5 Bridge high sense (green)
 - 1 Bridge low (0V) excitation (black)
 - 2 Bridge low sense (red)

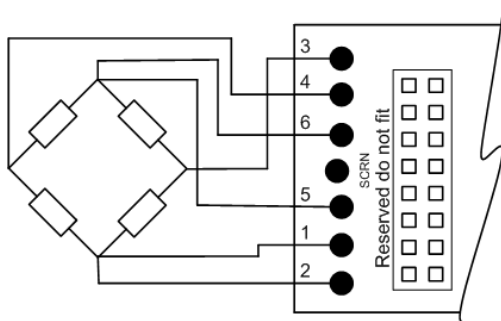

Full Bridge (Four Wire) Wiring

8.0 Full Bridge (Four Wire) Wiring

For 4 wire Link 5 to 6 and 1 to 2

Connecting a Strain Gauge Directly To PCB

If required the strain gauge can be connected directly to the SGIM PCB by removing the existing lead assembly with its ferrite core. Carefully solder the new strain gauge wires to the PCB including the screen.

For electrically noisy application e.g. industrial / long leads a ferrite core, such as Wurth elektronik part number 74270031 (Solartron part number 002001-00009) is recommended to be fitted close to SGIM input.

9.0 Precautions

Strain gauge sensors typically have a low, 0.6 to 62 mV/V output levels requiring a high gain amplifier, which may be sensitive to extraneous disturbances, in order to measure signals using an analogue to digital converter. Several points need to be considered to ensure the best performance.

10.0 Screen Connections

A good quality screened cable should be used to exclude interference. The cable screen should be continued to provide screening around the sensor.

11.0 Thermal emfs

Thermally induced emf's can be a significant source of errors. These can be minimised by ensuring that any connections (e.g. connectors etc) in the signal path are balanced thermally and kept in close proximity to each other.

Earth Loops

12.0 Earth Loops

A source of error which may arise due to currents carried through the screen connection. This must be avoided where possible by having only a single point of connection from the screen to ground.

Typical Gain Settings

Manufacturer	Type		mV/V	FS (mV)	Gain range
TME	F 501 TC	50 daN	1	5	9
TME	F 501 TC	> 50 daN	2	10	8
Vishay Celtron	S type	1 – 20 kg	2	10	8
Vishay Celtron	S type	25 – 5000 kg	3	15	7

Factory default gain range 8 (10 mV full range).